

ERCOLE "M"

VERSIONE : 02

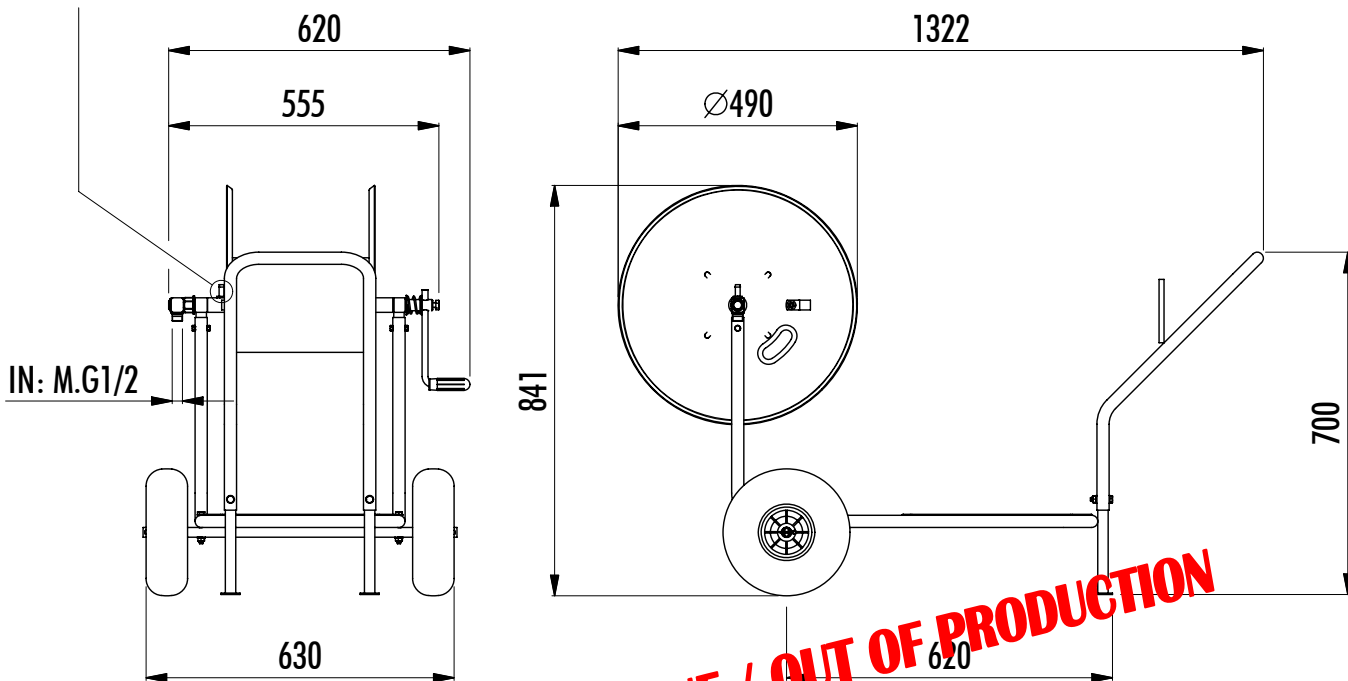

FUORI PRODUZIONE / OUT OF PRODUCTION

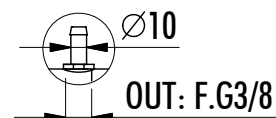
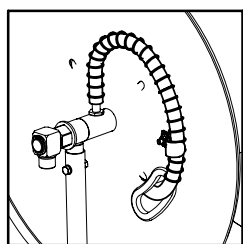
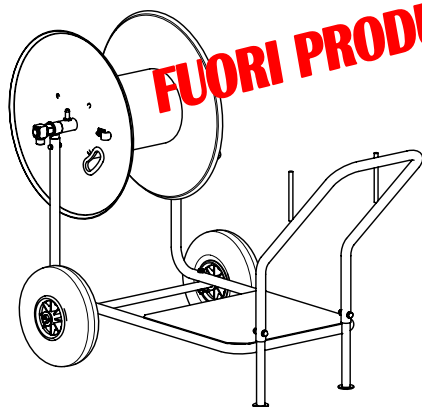

Montaggio tubo facilitato
Easily installable hose

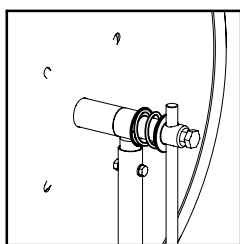

Molla frizione
Clutch spring

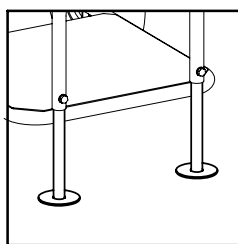

Piedini anti sprofondamento
Anti-sinking footpads

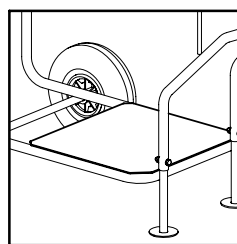

Base per motopompa
Pump set support

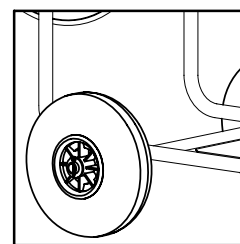

Ruote gonfiabili
Pumpable wheels

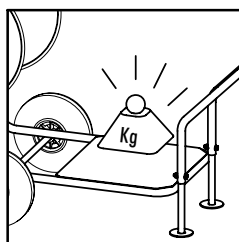

Telaio rinforzato
Reinforced chassis

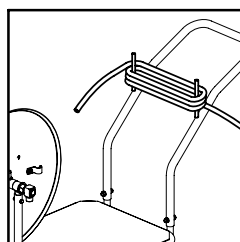

Supporto tubo di alimentazione
Hose rest

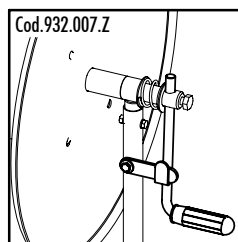

Cod.932.007.Z
Kit bloccaggio rullo (optional)
Kit reel stop (optional)

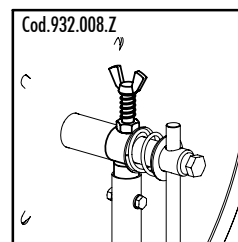

Cod.932.008.Z
Kit pipa frizione (optional)
Kit clutch (optional)

Codice verniciato Code painted	BAR	Lunghezza e diametro tubo consigliati Recommended hose length and diameter	Metri di tubo riavvolgibili calcolati su diversi diametri esterni in pollici e millimetri Metres of hose, which can be rewinded, calculated on different external diameters in inches and millimeters								Peso Weight	OPTIONAL		
			Ø 1/4		Ø 5/16		Ø 3/8		Ø 1/2			Kit bloccaggio rullo Kit reel stop	Kit pipa frizione Kit clutch	
			14	15	16	17	18	19	20	21				22
250.300.M	250	110 m - Ø 3/8	/	160	154	125	120	115	96	91	86	22.5 Kg	932.007.Z	932.008.Z